

Technische Präsentation

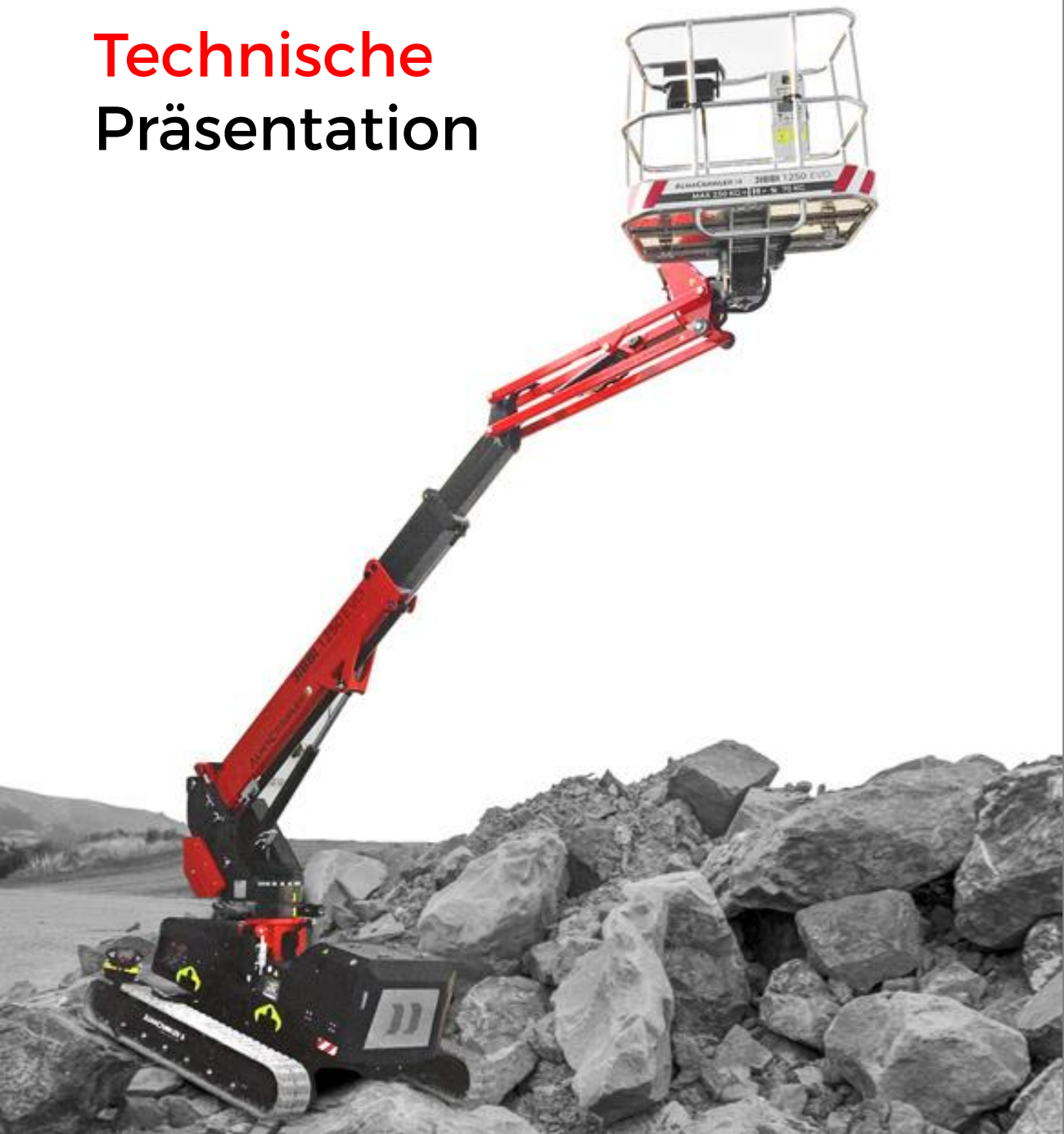

ALMACRAWLER

ALMAC-ITALIA.COM

JIBBI

1250 EVO

SELBSTFAHRENDE TELESKOPARBEITSBÜHNE

ALMACRAWLER

INNOVATIVE RAUPENBÜHNEN-TECHNOLOGIE



Neu **JIBBI 1250 EVO**

MAßE

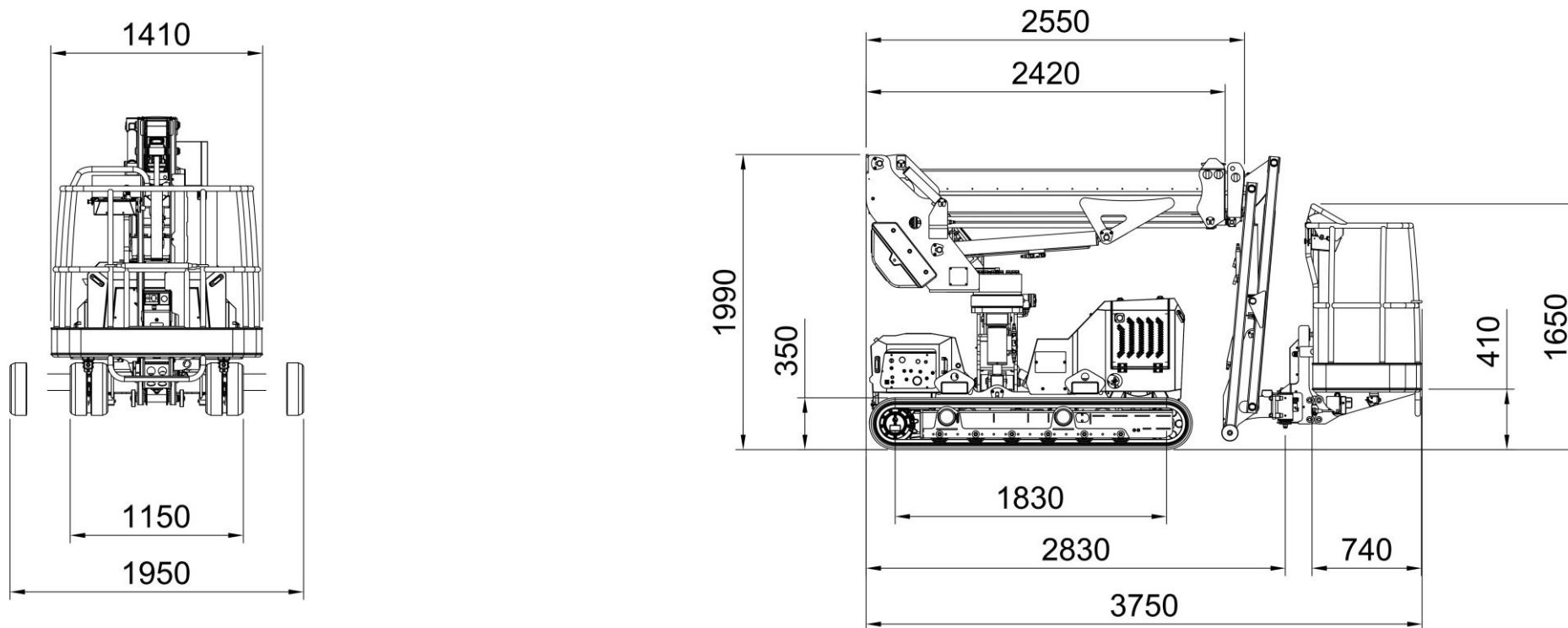

VERSTELLBARES
FAHRWERK

GESAMTGEWICHT: **NUR 2.850 KG**

AUSGESTATTET MIT EINEM LEISTUNGSSTARKEN 19,2 PS
DREIZYLINDER YANMAR-DIESELMOTOR

LEISTUNGS- UND ARBEITSDIAGRAMM

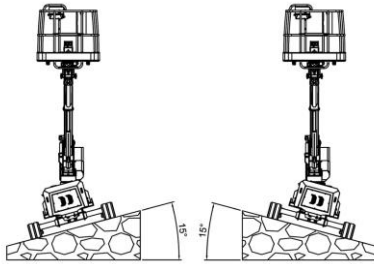

SEITLICHE
NIVELLIERUNG +/- 15°

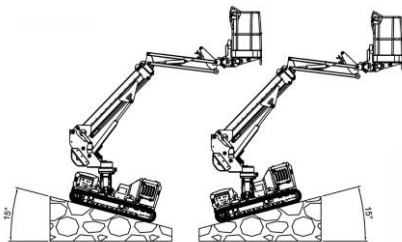

LÄNGSNIVELLIERUNG
+/- 15°

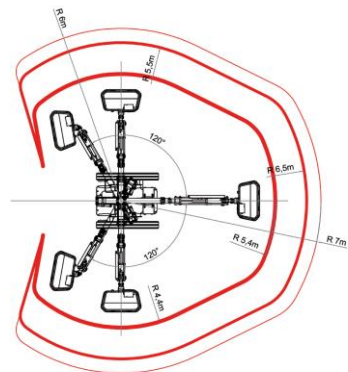

REICHWEITE VON
5,50 M BIS 7,00 M

— 80 kg
— 120 kg
— 230 kg

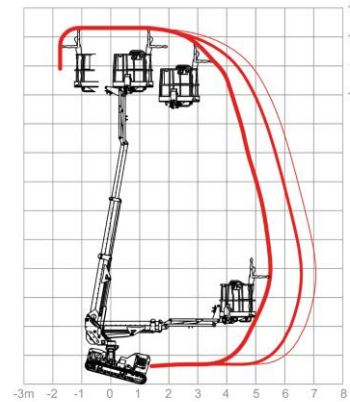

REICHWEITE ZUR FRONT

— 80 kg
— 120 kg
— 230 kg

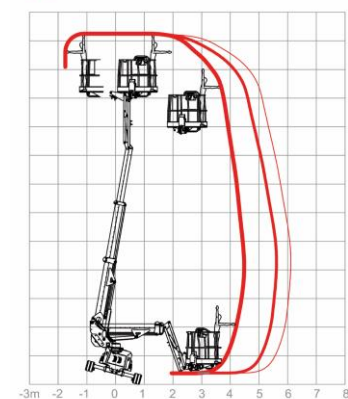

REICHWEITE ZUR SEITE



KABELSTEUERUNG VON **autec**[®]
(FARBDISPLAY 4,3 ZOLL)

ABNEHMBARER ARBEITSKORB

KORBLAST MAX. **230 KG**

KORBDREHUNG **+/- 70°**

OPTIONAL SEILWINDE-KIT
(MAX. TRAGFÄHIGKEIT VON **250 KG**)





**PROAKTIVES & DYNAMISCHES
NIVELLIERSYSTEM:**
UNTERSTÜTZT IHRE ARBEIT IN UNWEGSAMEN
GELÄNDE.

LÄNGSNIVELLIERUNG +/- 15°

SEITLICHE NIVELLIERUNG +/- 15°

DIAGONAL-NIVELLIERUNG +/- 22°



ARBEITSHÖHE BIS 12,20M



REICHWEITE VON 5,50M BIS 7,00M



DWP – DYNAMIC WORKING PERFORMANCE:

DYNAMISCHE STEUERUNG DER MASCHINENLEISTUNG ENTSPRECHEND DEN ARBEITSBEDINGUNGEN.

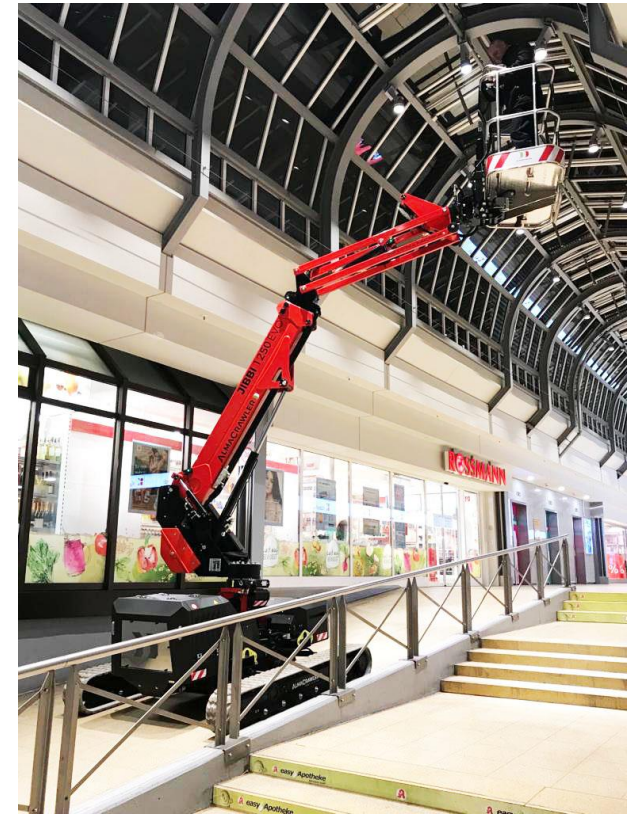
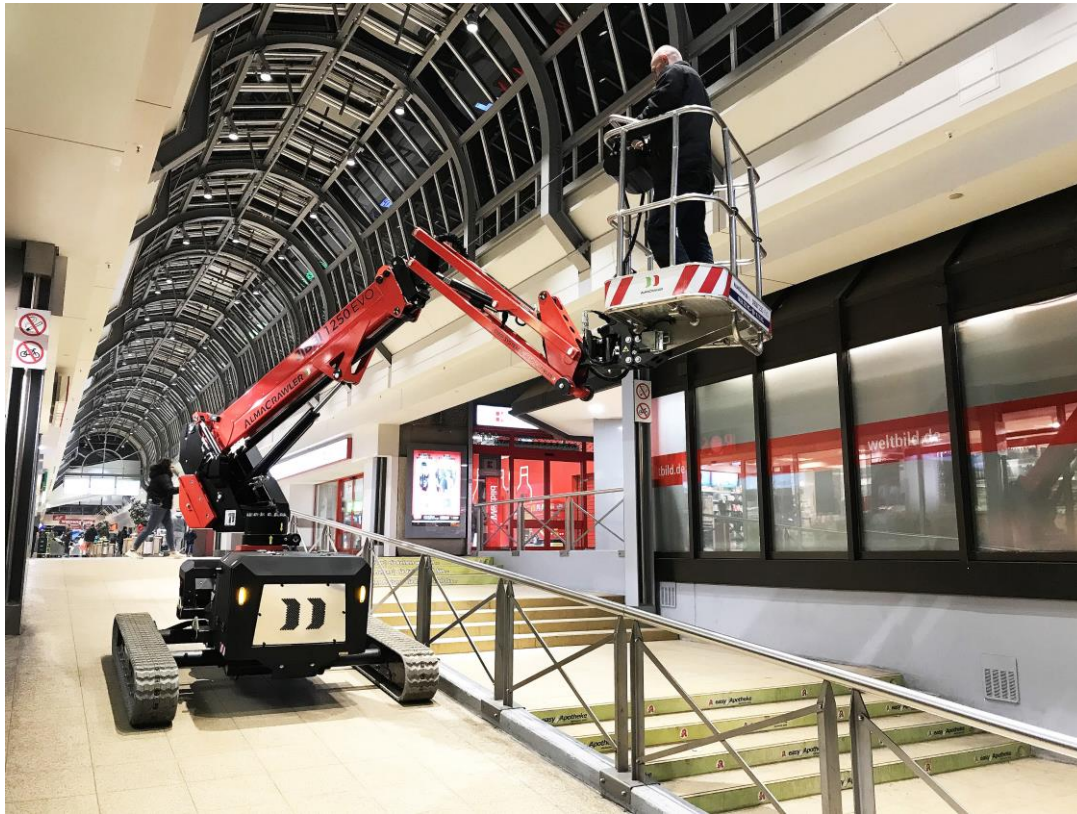

NEU ANTI-KOLLISIONS ULTRASCHALLSYSTEM:

ZUM SCHUTZ DES BEDIENERS ALS QUETSCHSCHUTZ AUF BEIDEN SEITEN DES KORBES (WÄHREND DEN AUF- UND ABBEWEGUNGEN).



GESAMTGEWICHT: **NUR 2.850 KG**

LEICHT ZU TRANSPORTIEREN

KOMPAKTE MAßE

ABNEHMBARER ARBEITSKORB

KONFIGURATOR

INDIVIDUALISIERE DEINE ALMAC

Sie können ihre arbeitsbühne nach ihren wünschen anpassen. wählen sie farbe motor und ausrüstung.

